

customer manual

| | | |
|--|--------------------------|---|
| SAFETY PRECAUTIONS | READ THIS FIRST ! | 2 |
| 1. INTRODUCTION | | 5 |
| 2. RECEIVING/INSPECTION | | 5 |
| 3. INSTALLATION/REMOVAL OF CRIMPING HEADS | | 5 |
| 3.1. Installation of Crimping Heads | | 6 |
| 3.2. Removal of Crimping Heads | | 6 |
| 4. OPERATION | | 6 |
| 5. PREVENTIVE MAINTENANCE | | 7 |
| 5.1. Daily Maintenance | | 7 |
| 5.2. Yearly Maintenance | | 7 |
| 6. SPARE PARTS | | 7 |
| 7. TROUBLESHOOTING | | 7 |
| 8. REPLACEMENT AND REPAIR | | 8 |
| 9. REVISION SUMMARY | | 8 |

Safeguards are designed into this application equipment to protect operators and maintenance personnel from most hazards during equipment operation. However, certain safety precautions must be taken by the operator and repair personnel to avoid personal injury, as well as damage to the equipment. For best results, application equipment must be operated in a dry, dust-free environment. Do not operate equipment in a gaseous or hazardous environment.

Carefully observe the following safety precautions before and during operation of the equipment:

- ALWAYS wear appropriate ear protection.
- ALWAYS wear appropriate eye protection.
- ALWAYS wear approved eye protection when operating powered equipment.
- ALWAYS keep guard(s) in place during normal operation.
- NEVER wear loose clothing or jewelry that may catch in moving parts of the application equipment.
- NEVER insert hands into installed application equipment.
- NEVER alter, modify, or misuse the application equipment.

SAFETY PRECAUTIONS -- IMPORTANT SAFETY INFORMATION

| | |
|---|---|
|  | DANGER |
| | <p>Electric shock hazard: This tool is not insulated. When using this unit near energized electrical lines, use proper personal protective equipment. Failure to observe this warning could result in severe injury or death.</p> |

| | |
|---|---|
|  | DANGER |
| | <p>Skin injection hazard: Do not use hands to check for oil leaks. High pressure oil easily punctures skin causing serious injury, gangrene, or death. If injured, seek medical help immediately to remove oil.</p> |

| | |
|---|---|
|  | DANGER |
| | <p>Do not use solvents or flammable liquids to clean the crimping tool. Solvents or flammable liquids could ignite and cause serious injury or property damage.</p> |

| |
|---|
| DANGER |
| <p>Do not dispose of batteries in a fire. They will vent fumes and may explode. Failure to observe this warning could result in severe injury from harmful fumes or burns from flying debris.</p> |

| |
|---|
| DANGER |
| <p>Inspect tool and dies before use. Replace any worn or damaged parts. A damaged or improperly assembled tool can break and strike nearby personnel. Failure to observe this warning could result in severe injury or death.</p> |

| | |
|---|--|
| DANGER | <i>This unit should only be used by trained competent personnel.</i> |
|  | |

| | |
|---|--|
|  | <i>Read and understand the entire manual before using the equipment.</i> |
|---|--|

| | |
|---|--|
|  | <i>Always wear approved eye protection when using the equipment.</i> |
|---|--|

| |
|---|
| CAUTION |
| <ul style="list-style-type: none"> Do not place the tool in a vise. The crimping tool is designed for hand-held operation. Protect the crimping tool from rain and moisture. Water will damage the crimping tool and battery. Use this tool for the manufacturer's intended purpose only. <p>Failure to observe these precautions may result in injury or property damage.</p> |

| |
|---|
| CAUTION |
| <p>Do not allow anything to contact the battery terminals.</p> <ul style="list-style-type: none"> Do not immerse the batteries in liquid. Liquid may create a short circuit and damage the battery. If batteries are immersed, contact your service center for proper handling. Do not place the battery into a pocket, tool pouch, or tool box with conductive objects. Conductive objects may create a short circuit and damage the battery. Do not place a battery on moist ground or grass. Moisture may create a short circuit and damage the battery. <p>Failure to observe these precautions may result in injury or property damage.</p> |

| |
|---|
| CAUTION |
| <ul style="list-style-type: none"> Do not store the battery at more than 60 °C (140 °F). Damage to the battery can result. Do not use another manufacturer's charger. Other manufacturers' chargers may overcharge and damage the battery. Do not attempt to open the battery. It contains no user-serviceable parts. <p>Failure to observe these precautions may result in injury or property damage.</p> |

| |
|--|
| CAUTION |
| <p>Do not perform any service or maintenance other than as described in this manual. Injury or damage to the tool may result. Failure to observe this precaution may result in injury and property damage.</p> |

NOTE: Keep all decals clean and legible, and replace when necessary.

TOOLING ASSISTANCE CENTER

CALL TOLL FREE 1-800-722-1111 (CONTINENTAL UNITED STATES AND PUERTO RICO ONLY)

The **Tooling Assistance Center** offers a means of providing technical assistance when required.

In addition, Field Service Engineers are available to provide assistance in the adjustment or repair of the application equipment when problems arise which your maintenance personnel are unable to correct.

INFORMATION REQUIRED WHEN CONTACTING THE TOOLING ASSISTANCE CENTER

When calling the Tooling Assistance Center regarding service to equipment, it is suggested that a person familiar with the device be present with a copy of the manual (and drawings) to receive instructions. Many difficulties can be avoided in this manner.

When calling the Tooling Assistance Center, be ready with the following information:

1. Customer name
2. Customer address
3. Person to contact (name, title, telephone number, and extension)
4. Person calling
5. Equipment number (and serial number if applicable)
6. Product part number (and serial number if applicable)
7. Urgency of request
8. Nature of problem
9. Description of inoperative component(s)
10. Additional information/comments that may be helpful

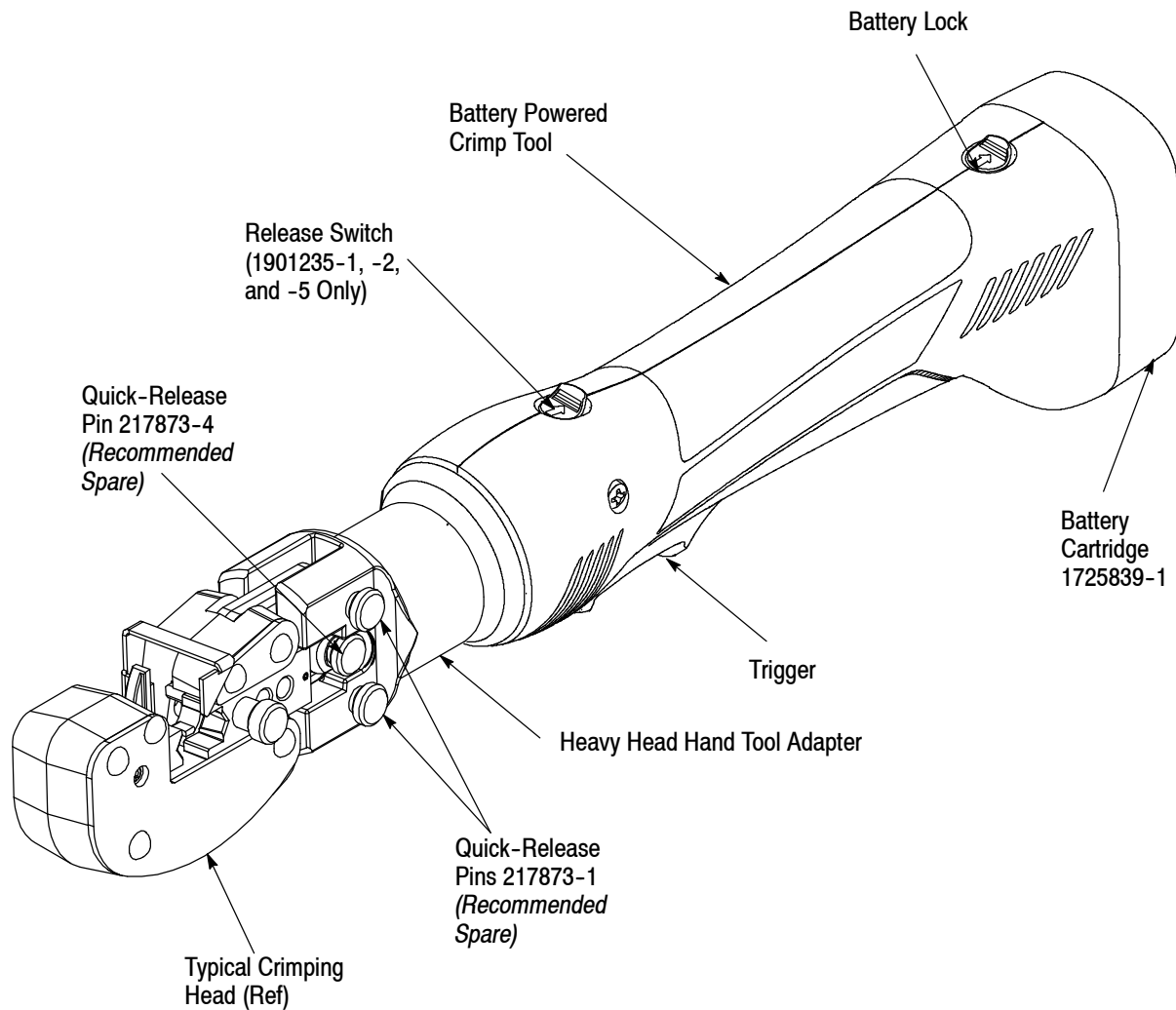

CRIMPING TOOL (with Battery Installed)

| | |
|-------------------------|------------------------|
| Length | 308 mm [12 1/8 In.] |
| Width | 54 mm [2 1/8 In.] |
| Depth | 76 mm [3 1/8 In.] |
| Mass/Weight (w/Battery) | 1.4 kg [3.1 lb.] |
| Sound Level | 75 dBA at 1 Meter |
| Vibration | < 2.5 m/s ² |
| Hydraulic Oil | Shell Tellus® T 15 |

CRIMPING CAPACITIES

| | |
|---------------------------|---------------------|
| Maximum Crimping Force | 15.6 kN [1.75 Tons] |
| Average Crimping Time | 2 Seconds |
| Average Crimps Per Charge | Approximately 150 |

BATTERY

| | |
|------------------|--------|
| Charging Voltage | 9.6 V |
| Charging Time | 40 Min |

Figure 1

1. INTRODUCTION

The Battery Powered Crimp Tool Kit 1901235-[] with Heavy Head Hand Tool (HHHT) Adapter is comprised of the battery crimp tool (with the Heavy Head Hand Tool Adapter installed), as well as two rechargeable battery cartridges (1725839-1) to power the tool. See Figure 1. Each kit has a battery charger. The battery charger part number, its voltage, and the kit’s region of use are listed in the table below. A battery tool may have a release switch to retract the ram as listed in the table below.

| BATTERY TOOL KIT | REGION OF USE | BATTERY CHARGER | BATTERY CHARGER VOLTAGE | RAM RETRACT SWITCH |
|------------------|----------------|-----------------|-------------------------|--------------------|
| 1901235-1 | North America | 1725840-1 | 110 V | Yes |
| 1901235-2 | Europe | 1725840-2 | 220 V | Yes |
| 1901235-3 | North America | 1725840-1 | 110 V | No |
| 1901235-4 | Europe | 1725840-2 | 220 V | No |
| 1901235-5 | United Kingdom | 1725840-3 | 220 V | Yes |

The Battery Powered Crimp Tool Kit is designed to adapt the crimping head from any HHHT listed in Figure 2 for use with the battery powered crimp tool. For crimp head information (including wire preparation, crimping procedures, maintenance and inspection procedures, as well as repair and replacement procedures) refer to the appropriate instruction sheet for the associated hand tool.

| HHHT PART NUMBER | DOCUMENT NUMBER | HHHT PART NUMBER | DOCUMENT NUMBER | HHHT PART NUMBER | DOCUMENT NUMBER |
|------------------|-----------------|------------------|-----------------|------------------|-----------------|
| 46866 | 408-1539 | 90382-2 | 408-6561 | 576780 | 408-10040 |
| 59287-2 | 408-1261 | 576778 | 408-10040 | 576781 | 408-10040 |
| 59239-4 | 408-1261 | 576779 | 408-10040 | 576782 | 408-10040 |

Figure 2

2. RECEIVING/INSPECTION

The Battery Powered Crimp Tool Kit 1901235-[] with HHHT Adapter is thoroughly inspected during and after assembly. Prior to packaging and shipping a final series of tests and inspections is made to ensure proper function of the tool. The following inspection should be performed as a safeguard against potential problems generated in transit.

1. In a well-lighted area, carefully uncrate the tool kit and inspect each component as it is removed from the crate.
2. Thoroughly inspect each component for evidence of damage that may have occurred in transit. If any of the components are damaged, file a claim against the carrier and notify Tyco Electronics immediately.
3. Keep this manual and all drawings and product samples with the tool for the benefit of operation and maintenance personnel.

The crimp tool should be inspected at regularly scheduled intervals, depending on care, degree of operator skill, the type and size of product being crimped, and environmental conditions. At a minimum, the tool should be inspected after every 40 hours of use.

3. INSTALLATION/REMOVAL OF CRIMPING HEADS

CAUTION Do not operate the tool without the HHHT adapter installed. Damage to the ram or seals can result.



CAUTION Do not operate the tool without a hand tool crimp head installed. Damage to the adapter can result.



Battery Powered Crimp Tool Kit 1901235-[] with HHHT Adapter comes with the HHHT adapter already installed on the battery powered hand tool. The only installation required is the installation of the crimping heads.



To avoid personal injury, be sure to exercise extreme caution when handling the crimp tool. Remove the battery before installing or removing crimping heads.

3.1. Installation of Crimping Heads

As supplied, the adapter has three quick-release pins installed (Figure 1). The two outer pins will be used to secure the links of the crimp head (exposed portion of the crimp head) to the adapter. The center pin will be used to secure the movable die of the crimp head to the ram of the adapter.

These pins must be removed prior to installing the crimping head.

1. Remove the battery from the tool.
2. Remove the quick-release pins, described above.
3. Insert the exposed portion of the crimp head into the adapter cavity. See Figure 1.
4. Insert the two outer quick-release pins through the holes in the adapter, and through the holes in the links of the crimping head.

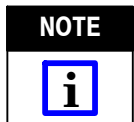

The quick-release pins will "snap" into position when they are properly inserted.

5. Insert the center quick-release pin into the adapter and through the holes in the ram and the moveable die of the crimp head.

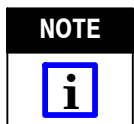

The quick-release pins will "snap" into position when they are properly inserted.

3.2. Removal of Crimping Heads



To avoid personal injury, remove the battery before removing crimping heads.

To remove the crimping head, it will be necessary to remove the quick-release pins and the crimp head from the battery powered crimp tool.

4. OPERATION

The following procedure provides only general information concerning crimping. Refer to the instructions packaged with the crimping head for detailed information, including wire stripping dimensions and instructions for positioning terminals and splices in the crimpers.

To operate the Battery Powered Crimp Tool 1901235-[] with HHHT adapter:



To avoid personal injury, keep fingers clear of the crimping area.

1. Insert the contact into the dies.
2. Depress the trigger to advance the moving jaw in order to hold the contact in place. Do NOT deform the insulation barrel or wire barrel.

3. Place a pre-stripped wire in the barrel of the contact.
4. Depress and hold the trigger to complete the crimp. The crimp tool returns automatically to the first position of its cycle when the crimp is complete.



If it is necessary to retract the ram before a crimping cycle is completed, push the release switch. Pushing the release switch will result in the complete retraction of the ram. Only kits 1901235-1, -2, and -5 have a release switch.



This tool is not designed for continuous operation. After 100 cycles, allow the crimp tool to cool for 15 minutes.

5. PREVENTIVE MAINTENANCE

5.1. Daily Maintenance

Perform the following maintenance on a daily basis:

1. Inspect the dies for wear or damage such as cracks, gouges, or chips.
2. Inspect the tool for damage or leaks. If damage is detected, return the tool to Tyco Electronics for repair
3. Clean the tool, removing accumulations of dirt and grease on the adapter, particularly in areas where heads are installed and contacts are crimped. Wipe the entire tool frequently with a clean, lint-free cloth.

5.2. Yearly Maintenance

Once a year, or every 10,000 cycles (whichever comes first) The Battery Powered Crimp Tool with HHHT Adapter should be returned to Tyco Electronics for inspection.

6. SPARE PARTS

- Battery: 1725839-1
- Charger: 1725840-1 (120 V, US), 1725840-2 (220 V, EU), 1725840-3 (220 V, UK)

7. TROUBLESHOOTING (Figure 3)

Prior to beginning troubleshooting procedures, be sure the battery is operational.

1. Be sure that the battery is charged. Recheck the battery after several minutes to ensure that the battery is holding its charge.
2. Use a nonflammable contact cleaner or pencil eraser to clean the the electrical contacts on the battery and crimp tool.
3. Reinstall the battery and check the crimp tool again.

| PROBLEM | PROBABLE CAUSE | REMEDY |
|-----------------------------|--|---|
| Tool is inoperative. | Dirt, contaminants, etc, in ram area of tool | Return tool to Tyco Electronics. |
| | Crimp tool battery contacts damaged | Reform the contacts. |
| | Tool components are worn or damaged. | Return tool to Tyco Electronics. |
| Dies stop during operation. | Oil level is low. | Return tool to Tyco Electronics. |
| | Air in the hydraulic system. | Pull the trigger and hold the retract button simultaneously. Hold for approximately 10 seconds. |
| Crimp tool loses oil. | Damaged internal seal. | Return tool to Tyco Electronics. |

Figure 3

8. REPLACEMENT AND REPAIR

DANGER

To avoid personal injury, ALWAYS remove the battery cartridge from the tool BEFORE performing any maintenance on the tool.

Replacement parts are identified in Figure 1. The recommended spares should be stocked for immediate replacement. Order replacement parts (or return parts) through your Tyco Electronics Representative, or call 1-800-526-5142, or send a facsimile of your purchase order to 717-986-7605. Or write to:

CUSTOMER SERVICE (38-35)
TYCO ELECTRONICS CORPORATION
P.O. BOX 3608
HARRISBURG, PA 17105-3608

NOTE

For replacement parts for crimping heads, refer to the instruction sheets packaged with the specific heads.

9. REVISION SUMMARY

- Updated document to corporate requirements
- Added new icons to Safety Precautions
- Added new text to Section 2
- Added new Paragraph 3.1.1 and renumbered
- Added new Section 6 and renumbered